

At home materials
Guidance Pack
Year 6 Weeks 1-4

Pack 4: Multiplication strategies

- Session A) Adjusting a factor by 1
- Session B) Monthly payments
- Session C) Adjusting a factor by 10
- Session D) Exploring calculation strategies

Pack 11: Division strategies

- Session A) Division and multiplication
- Session B) Halving strategies
- Session C) Division structures
- Session D) Models of division

Pack 10: Multiplication methods

- Session A) Short multiplication
- Session B) Models of multiplication
- Session C) 2-digit by 2-digit multiplication
- Session D) Long multiplication

Pack 12: Division methods

- Session A) Using knowledge of multiples
- Session B) Written division method
- Session C) Written long division method
- Session D) Division strategies



Timing

Each session is 30 minutes
20 minute Talk Task and 10 minute independent activity

Session guidance

Get **them** talking and grow their language.

Get **them** to use equipment, manipulatives, models and images to show and explain.

Challenge **them** to think mathematically. Use the Prompts for Thinking listed below to help them to build up habits in the way they think about mathematical situations.

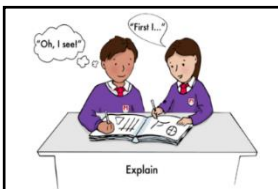

Reason it

Explain how you know. Focus on reasons rather than answers. What could you say, do, draw or write to help someone else understand?

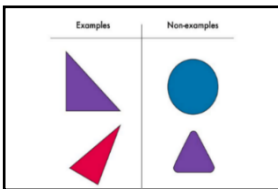

Generate examples and non-examples

What are the important features? What features are not important (e.g. colour)?

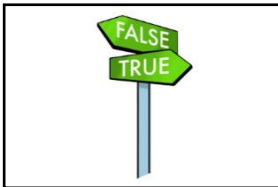

True or false?

If true, give examples to support your answer.
If false, give a counter example.

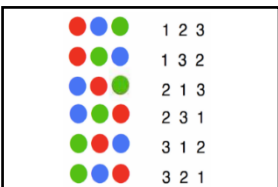

Find all possibilities

Have you found all the possible answers? How do you know? Did you work systematically?

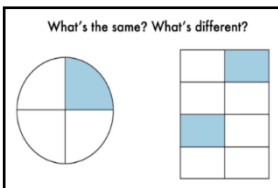

What's the same? What's different?

Compare and contrast and look for connections.
How many different answers can you give?



Always, sometimes or never true?

Give examples to show if the statement is always, sometimes or never true. How do you know?

Pack 4: Multiplication strategies	
Session A: Adjust a factor by 1	
Resources needed: Dienes thousands, hundreds, tens and ones	
<p>The purpose of this session is to explore the relationships between multiplication facts where one factor is one more or one less. You want to help pupils realise that they can use known facts to work out other facts</p>	
<p>Talk Task A situation is presented with seven bags each containing eight apples. Ask pupils to explain why the given calculation describes the total number of apples. Think about what happens when you adjust the situation and discuss and write calculations that can show the result each time. Think about the relationships between the calculations explored so far. E.g. <i>9 groups of 7 is 7 more than 8 groups of 7</i> The second set of calculations are outside of the ‘times tables’ in order to prompt pupils to use the given fact rather than work out each calculation separately. Although, it is also useful to work each one out to check. A calculation is placed on a number line and pupils are prompted to use this to place related facts on the line. Think about the relationship between the calculations by completing the sentences. The parts of a multiplication calculation can be called factor × factor = product This can be useful language when trying to describe the general relationships explored. <i>If a factor is decreased by 1, the product is decreased by the value of the other factor.</i> <i>If a factor is increased by 1, the product is increased by the value of the other factor.</i></p>	
<p>Activity The activity sheet guides students through tasks similar to the talk task. Then chains of calculations are used to help pupils think about the relationship between multiples of 5 and multiples of 6 and between multiples of 9 and multiples of 10. Extend the activity by asking students to select a calculation and write related multiplication and division facts. Challenge them to make or draw models to represent the calculations.</p>	<p><u>Video guidance</u></p> 



Activity: Derived facts – adjusting a factor by 1

- 1) Use the known fact to place the calculations onto the number line and complete the statements to describe the relationship.

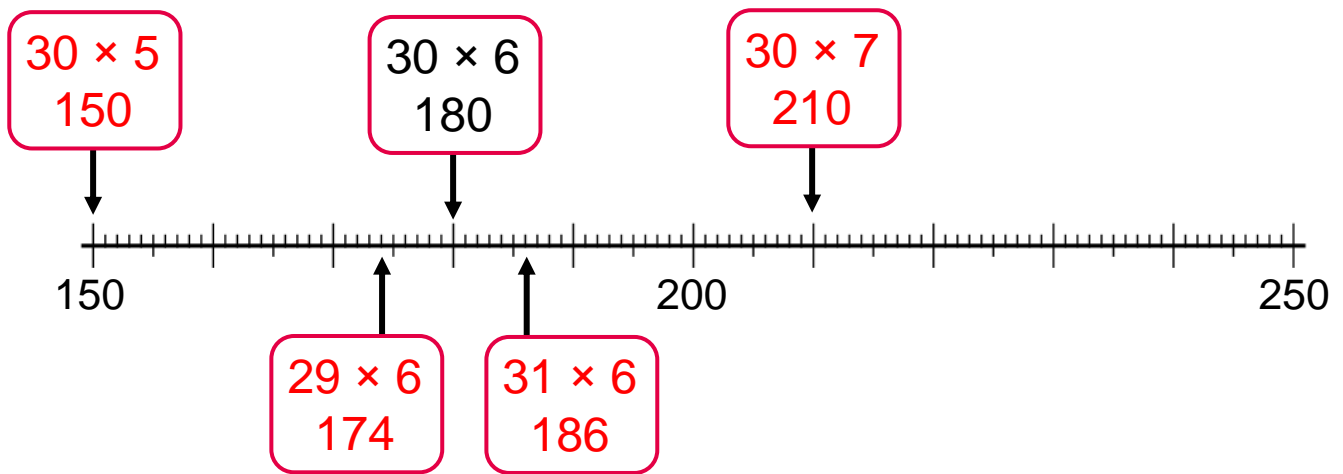

29×6 is **6** less than 30×6

31×6 is **6** more than 30×6

30×5 is **30** less than 30×6

30×7 is **30** more than 30×6

- 2) Complete the calculations. What relationships do you notice..

$$3 \times 5 + 3 = 3 \times 6$$

$$9 \times 2 = 20 - 2$$

$$4 \times 5 + 4 = 4 \times 6$$

$$9 \times 3 = 30 - 3$$

$$5 \times 5 + 5 = 5 \times 6$$

$$9 \times 4 = 40 - 4$$

$$6 \times 5 + 6 = 6 \times 6$$

$$9 \times 5 = 50 - 5$$

$$7 \times 5 + 7 = 7 \times 6$$

$$9 \times 6 = 60 - 6$$

$$9 \times 14 = 140 - 14$$

Pack 4: Multiplication strategies

Session B: Monthly payments

Resources needed: Individual whiteboard to draw number lines

The purpose of this session is to use what they know about related multiplication facts to multiply a 2-digit number. A table of values and a double number line are used to record information and a variety of strategies should be explored.

Talk Task

Connect the context of the Talk Task to students' experiences by asking if they have ever had pocket money, or a job that paid the same amount on a regular basis. Do they (or do they know anyone) who makes regular payments each month?

Discuss the first situation and the table of values, asking students to explain how the table relates to the situation.

The table shows how much it will cost after 1 month, 2 months and 10 months.

Explore strategies to find other values in the table

5 months will be half the cost of 10 months. Half of 18 is 9. Half of 180 is 90.

6 months will be £18 more than 5 months.

4 months is double the cost of 2 months or £18 less than the cost of 5 months.

A double number line is a useful tool for seeing relationships and keeping track of calculation steps. Explore the information on the number line, connect to the table and the context and record more values.

Repeat a similar experience with the second situation.

Extend the activity by asking students to extend the double number lines.

What values can you record further along the line? How much will it cost for 2 years, 24 months?

Activity

The activity sheet guides students through using tables and double number lines in the context of monthly payments across a year. The last situation does not give the value of one payment. Support might be needed to think about how to use the information given.

The difference between 5 and 6 months will be the cost of a month. I can use 5 months to find the cost of 10 months.

[Video guidance](#)



Activity: Monthly payments

For each situation, write as much information as you can about the cost across a year.

My contact lenses cost £14 each month.



Month	1	2	3	4	5	6	7	8	9	10	11	12
Cost	14	28	42	56	70	84	98	112	126	140	154	168

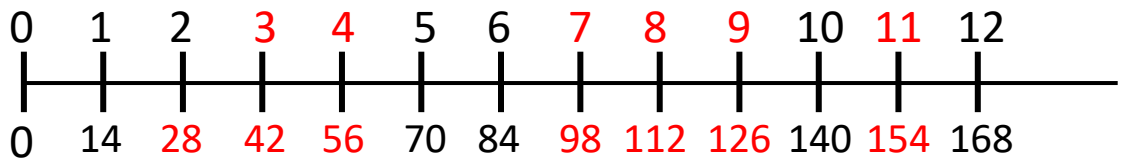

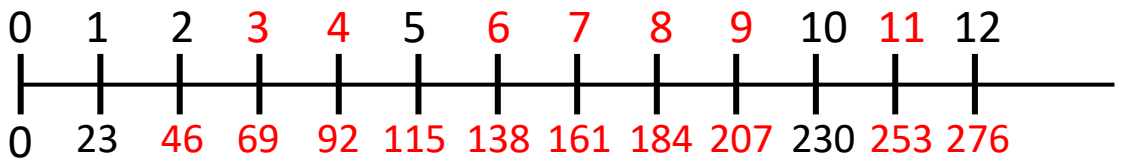

My mobile phone costs £23 each month.

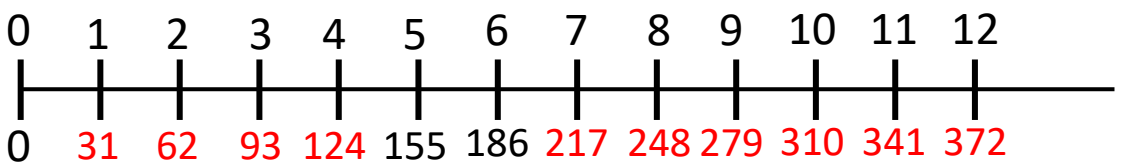

After 5 months I have paid £155

After 6 months I have paid £186



Pack 4: Multiplication strategies	
Session C: Adjusting a factor by 10	
Resources needed: Dienes hundreds, tens and ones	
The purpose of this session is to explore partitioning strategies and the relationship between calculations where a factor is ten more or less. Dienes and area models are used to prompt discussion and reveal the structure.	
<p>Talk Task Ask pupils to describe the Dienes and area models on the talk mat.</p> <p><i>What do you see? What do you notice?</i></p> <p>Take the time to discuss and explain how each model shows each calculation, discussing what has changed as you move down the page.</p> <p>From the second model, the calculations are written in two ways. Ask pupils to explain how the model shows the calculation.</p> <p><i>The two digit number is partitioned into tens and ones and each part is multiplied. This is shown in the tens and ones.</i></p> <p>Continue to discuss the models and calculations, working out the answer and explaining why the calculations are equal.</p> <p>At the end of the page, a double number line is shown with the values from the model above. Spend time describing how the number line is connected to the Dienes and the calculations. If you have not already done so, focus on the difference between the total value for each model/calculation and discuss why it increases by 40.</p> <p>Extend the activity by asking students to imagine the sequence of calculations continuing. <i>What would come next? What would the model look like?</i></p>	
<p>Activity The activity sheet provides a similar experience as in the Talk Task connecting a model of Dienes to area models using rectangles.</p> <p>Students have the opportunity to sketch models to represent calculations and complete statements to describe the relationship between calculations.</p> <p>Extend the activity by building models with Dienes and sketching area models and writing abstract calculations..</p>	<p><u>Video guidance</u></p> 



Pack 4 Session C

Activity: Derived facts –adjusting by a factor by 10

1) Label the area models and complete the calculations.

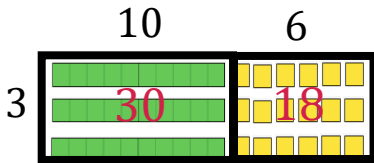

$$16 \times 3 = 30 + 18 = 48$$

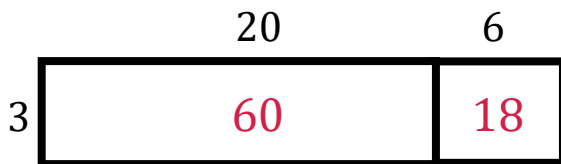

$$26 \times 3 = 60 + 18 = 78$$

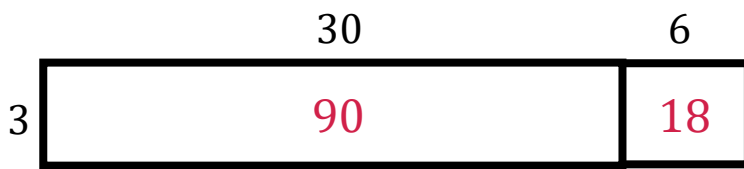

$$36 \times 3 = 90 + 18 = 108$$

2) Draw models to represent multiplication calculations

Draw an array with Dienes to represent 24×3

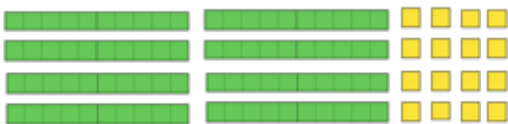

Draw and label a rectangle to represent 29×4

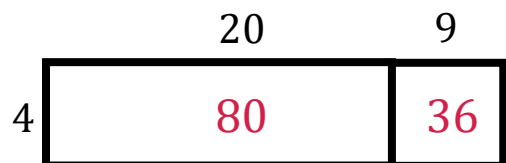

3) Complete the statements.

14×5 is 50 more than 4×5

8×3 is 30 less than 18×3

16×4 is 40 more than 6×4

8×7 is 70 less than 18×7

Pack 4: Multiplication strategies	
Session D: Exploring calculation strategies	
Resources needed: Dienes thousands, hundreds, tens and ones	
<p>The purpose of this session is to explore different ways to complete the same calculation and describe how strategies works. Understanding from previous sessions and packs is drawn upon to develop flexibility when calculating.</p>	
<p>Talk Task The talk mat show four different strategies for calculating 75×4. The answer, 300, is provided as the purpose is not to find the answer but instead to explore the different strategies and explain how they work.</p> <p>Each strategy has been represented with a model. Take the time to think about each model and describe how each step of the calculation strategy is shown. Below are some suggestions for ways to talk about each model:</p> <p><i>The bars double in length as you go down. Doubling and doubling again is the same as multiplying by 4.</i></p> <p><i>The open array shows that 75 has been split into 70 and 5 and each part multiplied by 4.</i></p> <p><i>This open array shows 80×4 is 20 more than 75×4</i></p> <p><i>The counters show that 75 is split into 3 lots of 25. There are 12 lots of 25 and 4×25 is 100.</i></p> <p>Discuss which strategy is the most efficient. There is no definite answer to this and the purpose of the discussion is not to decide which but rather to think about what makes a strategy efficient.</p>	
<p>Activity The activity sheet has two models representing different strategies for calculating 15×8 and students are to complete the steps of the calculations. Then students are given space to record three different strategies for completing the same calculation. Encourage them to draw and write for each.</p> <p>Extend the activity by discussing names for different strategies you have used and thinking of other calculations when you would use each. For example, a doubling strategy can be used when multiplying by four. Draw similar models to represent other calculations.</p>	<p>Video guidance</p> 

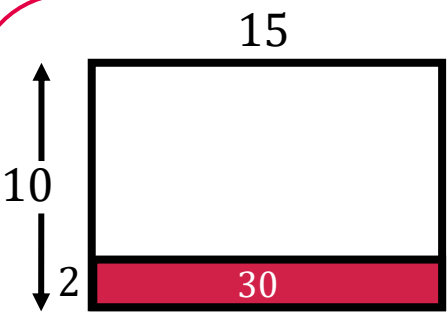

Activity: Exploring calculation strategies1) Complete the calculations for two ways to calculate 15×8

$15 \times 8 = 15 \times 10 - 15 \times 2$
 $= 150 - 30$

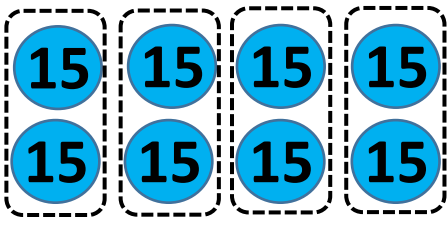

$15 \times 8 = 15 \times 2 \times 4$
 $= 30 \times 4$

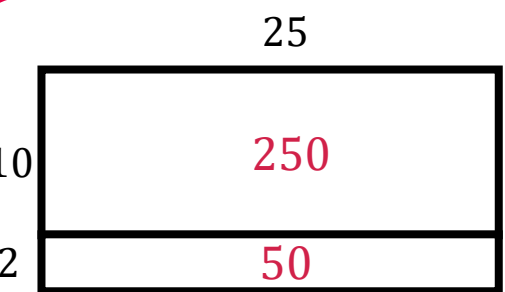
2) Show with models and calculations three different ways to calculate 25×12

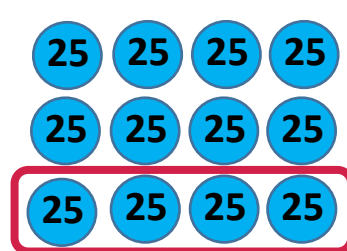

$25 \times 12 = 25 \times 10 + 25 \times 2$
 $= 250 + 50$

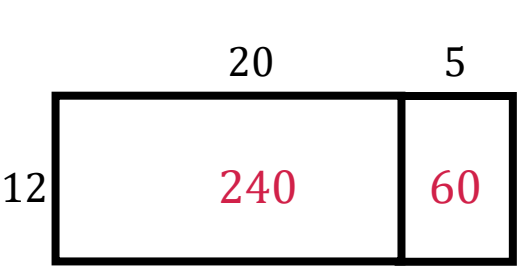

$25 \times 12 = 25 \times 4 \times 3$
 $= 100 \times 3$



$25 \times 12 = 20 \times 12 + 5 \times 12$
 $= 240 + 60$

Pack 11: Division	
Session A: Division and multiplication	
Resources needed: Counters (or applicable alternative)	
The purpose of this session is to revise understanding of the connection between multiplication and division and use knowledge of multiples to make sense of division calculations.	
<p>Talk Task</p> <p>An array of counters each labelled with the value of 10 is presented. Ask pupils to tell you what they can see and describe any calculations they think the model represents. This should be a familiar model of multiplication and pupils should be able to identify and describe equal groups and write multiplication calculations.</p> <p>Use the suggested sentences to discuss the language ‘multiple of’ and ‘divisible by’. Connect these ideas using the array of counters to support explanations.</p> <ul style="list-style-type: none"> • 210 is a multiple of 70 • 210 is divisible by 70. I can divide 210 into 3 groups of 70 • 210 is a multiple of 3 • 210 is divisible by 3. I can divide 210 into 3 equal groups. Each group is 70. <p>Think carefully about how to describe the division based on the model. For example, it is not easy to see 210 divided into 70 groups of 3 with this model.</p> <ul style="list-style-type: none"> • 210 is a multiple of 30 • 210 is divisible by 30. I can divide 210 into 7 groups of 30. • 210 is a multiple of 7 • 210 is divisible by 7. I can divide 210 into 7 equal groups. Each group is 30. <p>While working through these, write division calculations that the array can represent. Pause and reflect on the many calculations that can be worked out.</p> <p>For the next section, build on the derived facts identified so far to identify numbers that are divisible by 7. A number line is provided that restricts the task to numbers between 130 and 230. For each number identified, discuss how you know and how to record as a division calculation and a multiplication calculation.</p>	
<p>Activity</p> <p>This activity guides students through a similar experience of deriving and recording facts. Then a multiplication fact is given and pupils are to use this to solve word problems involving division and related facts. Extend this task by asking pupils to generate their own word problems.</p>	<p>Video guidance</p> 



Activity: Division and multiplication

1) Copy and complete the calculations this array could represent as the value of each counter is changed.

a) Each counter has a value of (1)

$$3 \times 8 = 24$$

$$8 \times 3 = 24$$

$$24 \div 8 = 3$$

$$24 \div 3 = 8$$

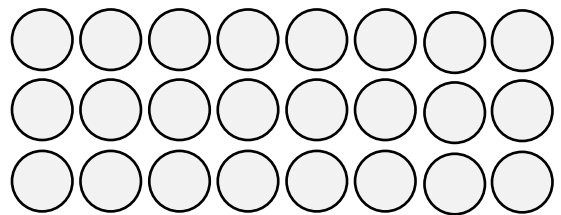

b) Each counter has a value of (10)

$$30 \times 8 = 240$$

$$8 \times 30 = 240$$

$$240 \div 8 = 30$$

$$240 \div 30 = 8$$

$$3 \times 80 = 240$$

$$80 \times 3 = 240$$

$$240 \div 3 = 80$$

$$240 \div 80 = 3$$

$$24 \times 10 = 240$$

$$10 \times 24 = 240$$

$$240 \div 10 = 24$$

$$240 \div 24 = 10$$

2) Use the fact that $4 \times 6 = 24$ to answer the following:

£240 is shared equally between 4 people. How much does each person get?

£60

240 grams of sugar is split into bowls with 60 g in each. How many bowls of sugar are there?

4 bowls of sugar

Completing a level of a game gets you 60 points. You have 2400 points. How many levels have you completed?

40 levels

I do 40 minutes of exercise every day. How many days until I have done 240 minutes?

6 days

Pack 11: Division	
Session B: Halving strategies	
Resources needed: Dienes	
<p>The purpose of this session is to explore different division strategies that involve halving. Exploring different ways to complete the same calculation allows you to discuss which strategy you would choose.</p>	
<p>Talk Task</p> <p>Four models are shown to represent different ways of seeing half of 72. Start by asking pupils to describe what they can see and discuss what is the same and what is different. Encourage pupils to build and label each model.</p> <p>Below the models are four sets of calculations describing the steps of four different strategies. Read and discuss which matches which model and think about why and how you can see each calculation in the arrangement of the blocks. Take the time to attach each step of the calculation to the model that it matches, describing the role of each number.</p> <p>The top two strategies partition 72 and halve each part. On the left, 72 is partitioned into 70 and 2 and on the right into 60 and 12. It is importance to encourage pupils to be flexible in their choices of how to partition and consider options other than tens and ones.</p> <p>The bottom two strategies identify a multiplication calculation and halve one of the factors to halve the product.</p> <p>Having discussed each model and strategy, talk about which you would choose to use for this calculation and think about other calculations that suit each strategy. Extend this task by exploring a similar calculation such as $58 \div 2$ or $96 \div 2$ and building or drawing models that show different ways this could be calculated. The focus should be on explaining and seeing the structure.</p>	
<p>Activity</p> <p>The activity sheet uses arrays of counters to illustrate division strategies involving halving and repeated halving. Pupils are to look at each step and complete the model by drawing rings around sections of the array and complete the empty boxes</p> <p>Extend this task by challenging students to find other calculations that suit each of the strategies explored as well as calculation that do not.</p>	<p><u>Video guidance</u></p> 



Activity: Halving strategies

- 1) The images show a halving strategy. Complete the boxes.

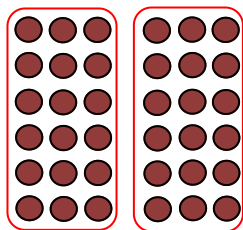

Two groups of 18

$$36 \div 2 = 18$$

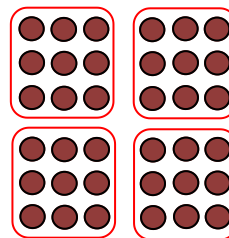

Four groups of 9

$$36 \div 4 = 9$$

- 2) Complete the images to match the steps of the halving strategy.

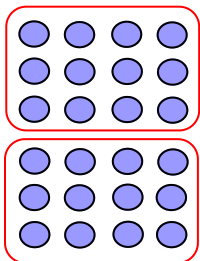

Half of 24 is 12

$$24 \div 2 = 12$$

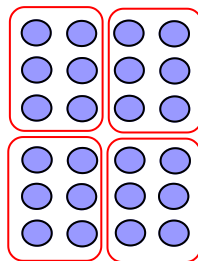

Half of 12 is 6

$$24 \div 4 = 6$$

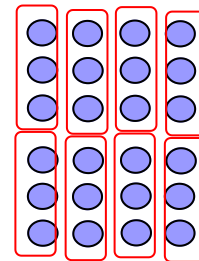

Half of 6 is 3

$$24 \div 8 = 3$$

- 3) Complete the strategy and show it works with another calculation.



To divide a number by 6, I
can halve and then divide by 3

Half of 48 is 24

24 divide by 3 is 8

$$48 \div 6 = 8$$

Half of 186 is 96

96 divide by 3 is 32

$$186 \div 6 = 32$$

There are different ways to complete question 2 and many different examples that could be given for question 3.

Pack 11: Division	
Session C: Division structures	
Resources needed: A way to draw number lines	
<p>The purpose of this session is to explore different ways of interpreting the same division calculation. Division as sharing and division as grouping. For example, $10 \div 2$ can mean 10 shared between 2 or it can mean 10 put into groups of 2. Number lines are used as the model for exploring this.</p>	
<p>Talk Task</p> <p>Division calculations can be interpreted in two different ways and these different ways of seeing division can lead to different calculation strategies. This task uses number lines as the model to explore the same calculation in two different situations.</p> <p>Read what each person says and think about what is the same and what is different between the two situations.</p> <ul style="list-style-type: none"> <i>In both we know the total number and it is the same, 150</i> <i>We know the number of pencils in each pack, 30. We don't know the number of packs.</i> <i>We don't know the number of pens in each pack. We know the number of packs, 30.</i> <p>Ask pupils to explain why the same calculation, $150 \div 30$ can be used to solve both situations. Highlight that this calculation can mean 'how many 30s in 150?' or it can mean '150 is split into 30 equal groups, how many in each group?'</p> <p>Look at the number line for each situation and spend time making sense of the information displayed. Ask pupils to place more information onto each line.</p> <p><i>One pack is 30 pencils, how many packs of 30 is 150? Two packs is 60, four packs is 120 and five packs is 150 pencils.</i></p> <p><i>150 pens is the amount in 30 packs, what is 150 divided into 30 equal parts? 10 packs is 150 divided into 3 which is 50. If 10 packs is 50 then 1 pack has 5 pens.</i></p>	
<p>Activity</p> <p>The activity sheet uses the context of frogs jumping to provide further practice with using a number line. Extend the activity by asking pupils to record multiplication and division calculations that each question is connected with. They can also generate their own situations to show the two interpretations of division.</p>	<p><u>Video guidance</u></p> 

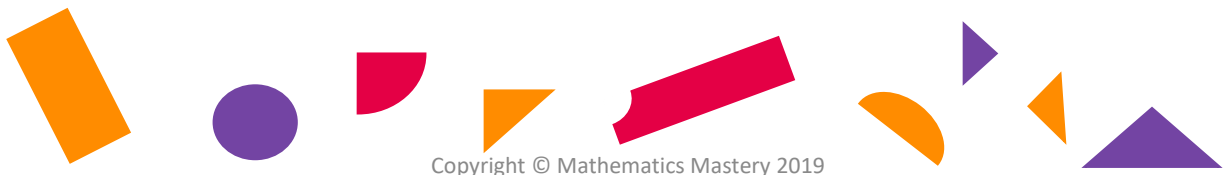

Activity: Division structures

1) A frog travels 8cm for each jump.

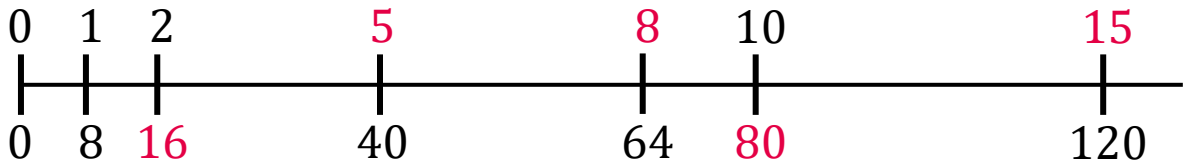

- a) How far has it travelled after 2 jumps?
- b) How many jumps does it take to travel 40 cm?
- c) How many jumps does it take to travel 64 cm?
- d) How far has it travelled after 10 jumps?
- e) How many jumps does it take to travel 120 cm?

2) This frog has jumped 15 equal jumps and travelled 75 cm.

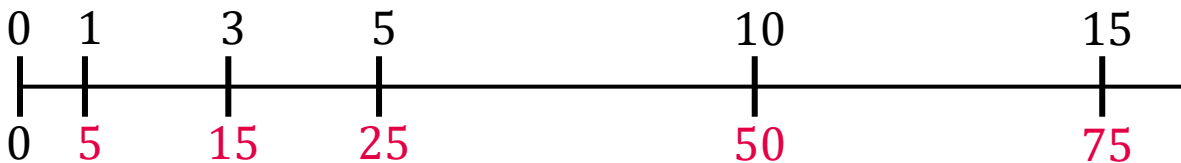

- a) How far has it travelled after 5 jumps?
- b) How far has it travelled after 10 jumps?
- c) How big is each jump?
- d) How far has it travelled after 3 jumps?

Pack 11: Division	
Session D: Models of division	
Resources needed: Dienes	
<p>The purpose of this session is to explore different models for representing division. All of the models have been used in previous packs to represent multiplication showing that knowledge of multiples can be used to divide.</p>	
<p>Talk Task</p> <p>Three different models are provided with some labels. Start by asking pupils to describe what they see, encouraging them to label the models and think about calculations they could represent.</p> <p>Three division calculations are given. Take time to match each calculation to a representations prompting pupils to give clear explanations and show why.</p> <p>The array of Dienes shows 9 tens and 3 ones which is 93. This has been divided into 3 equal rows and each row has length 31. This can represent the multiplication calculation $31 \times 3 = 93$ and so it also represents the division calculation $93 \div 3 = 31$.</p> <p>The rectangle is labelled with an area of 124. One side has length 4 and this information connects it to the division calculation $124 \div 4$. Take time to discuss why the other length must be 30 and 1.</p> <p>The number line shows one part with a value of 3, 30 parts with a value of 90, and asks what number of parts have a value of 96. It is asking how many threes are there in 96. This is the division calculation $96 \div 3 = 32$</p> <p>Having discussed each of the models and the calculations they represent, discuss what is the same, what is different and what is the relationship between these calculations. You can extend the session by creating the other models for each calculation and by varying the calculations in other ways and representing those.</p>	
<p>Activity</p> <p>The activity sheet provides similar experiences of completing calculations, labelling models and using understanding of multiplication to divide. The final question asks pupils to create a representation for a given calculation. There are lots of possible ways to do this and you can encourage pupils to create more than one representation.</p>	<p>Video guidance</p> 



Activity: Models of division

1) Label the models and complete the calculations.



$$92 \div 4 = 23$$

$$23 \times 4 = 92$$

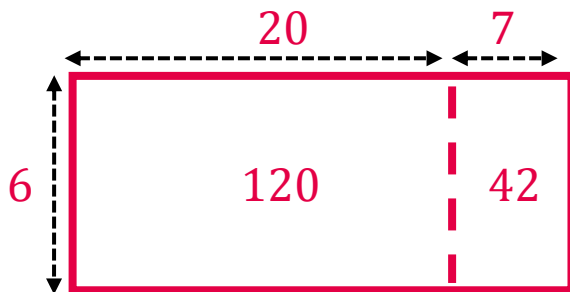

$$162 \div 6 = 27$$

$$27 \times 6 = 162$$

2) Complete the calculations and label the number line.

a) $4 \times 6 = 24$

$24 \div 6 = 4$

b) $30 \times 6 = 180$

$180 \div 6 = 30$

c) $34 \times 6 = 204$

$204 \div 6 = 34$

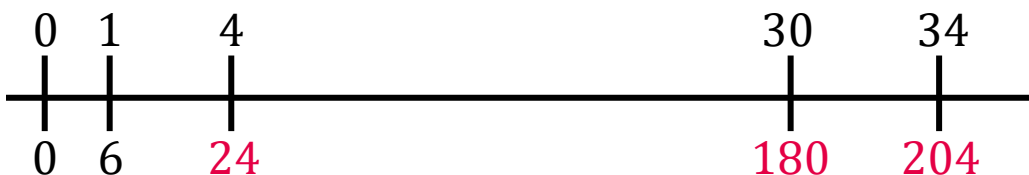

3) Draw a model to represent $72 \div 3 = 23$.

There are lots of ways to complete this. Look for models that show 72 as 3 groups of 23 or as 23 groups of 3.

Pack 10: Multiplication methods	
Session A: Short multiplication models	
Resources needed: Dienes	
<p>The purpose of this session is to use and explain the written method of multiplication. Aim for more than describing the steps needed to complete the method. Aim to support pupils in using the manipulatives and models to show and explain what is happening as each step is carried out.</p>	
<p>Talk Task</p> <p>Two calculations are explored during this task. The first is presented with a completed image but incomplete calculation and the second is presented with a completed calculation but incomplete image. Ask pupils to look at the sheet and think about what they will be asked to do. Start with the image of the first calculation and use Dienes to create this. Discuss each step of the method and how to write the completed calculation.</p> <ul style="list-style-type: none"> • <i>3 ones multiplied by 4 is 12 ones</i> (place 4 groups of 3 ones) • <i>10 ones are regrouped as 1 ten</i> (line up ten ones and place 1 ten next to it. Remove the ten ones) <p>Rather than ‘carry the one’, use the word ‘regroup’ in order to emphasise that the value has not changed, it is grouped in a different way.</p> <ul style="list-style-type: none"> • Record 2 in the ones place and a small 1 below the tens place. • <i>2 tens multiplied by 4 is 8 tens. Include the regrouped ten. There are 9 tens.</i> • Record 9 in the tens place. <i>23 multiplied by 4 is equal to 92</i> <p>The next calculation has been completed and you can work together to build and sketch models to represent the steps. This calculation involves regrouping twice.</p> <p>After completing both calculations, make connections to previous models by arranging Dienes in rows. Look at the numbers involved and describe the relationships. The number line can be used to support this discussion.</p>	
<p>Activity</p> <p>The activity sheet explores incorrectly completed calculations prompting pupils to identify and correct the errors. Extend the activity by asking pupils what they would do, draw, say or write to help someone understand. Then pupils explore different calculations that can be created with three digits. Pupils may need support in finding all six possibilities. Extend the session by discussing the questions. This task is repeated in session B and can be built upon then.</p>	<p><u>Video guidance</u></p> 



Pack 10 Session A

Activity: Short multiplication

Answers



1) What has gone wrong? Write the correct calculation under each error.

$$\begin{array}{r} 26 \\ \times 3 \\ \hline 618 \end{array}$$

Didn't regroup

$$\begin{array}{r} 26 \\ \times 3 \\ \hline 78 \\ \hline 1 \end{array}$$

$$\begin{array}{r} 45 \\ \times 4 \\ \hline 49 \end{array}$$

Added the digits

$$\begin{array}{r} 45 \\ \times 4 \\ \hline 180 \\ \hline 2 \end{array}$$

$$\begin{array}{r} 36 \\ \times 7 \\ \hline 212 \end{array}$$

4
Forgot to include regrouped 4 tens

$$\begin{array}{r} 36 \\ \times 7 \\ \hline 252 \\ \hline 4 \end{array}$$

2) Using the digits 3, 4 and 5, what products can you make?

$$\begin{array}{r} 34 \\ \times 5 \\ \hline 170 \\ \hline 2 \end{array}$$

$$\begin{array}{r} 35 \\ \times 4 \\ \hline 140 \\ \hline 2 \end{array}$$

$$\begin{array}{r} 43 \\ \times 5 \\ \hline 215 \\ \hline 1 \end{array}$$

$$\begin{array}{r} 45 \\ \times 3 \\ \hline 135 \\ \hline 1 \end{array}$$

$$\begin{array}{r} 53 \\ \times 4 \\ \hline 212 \\ \hline 1 \end{array}$$

$$\begin{array}{r} 54 \\ \times 3 \\ \hline 162 \\ \hline 1 \end{array}$$

● ● ●	1 2 3
● ● ●	1 3 2
● ● ●	2 1 3
● ● ●	2 3 1
● ● ●	3 1 2
● ● ●	3 2 1

Find all 6 possibilities.

What do you notice about the products?

Why are there four multiples of 5?

Pack 10: Multiplication methods**Session B:** Models of multiplication**Resources needed:** Dienes. Scissors and plain paper.

The purpose of this session is to build confidence with using models to represent multiplication. Pupils use these models to demonstrate their understanding of the written method of multiplication. Area models are used in the next two sessions to support understanding when calculating with larger numbers.

Talk Task

Three models and three calculations are provided. Cut these up so they can be moved around. Look at the models and discuss what they could show and why. Encourage pupils to point and describe what they can see in each model. Building or drawing a copy can be a useful way to make sense of the information.

Discuss which model represents which written calculation and why. Use the models to discuss the steps of the written method and give pupils time to demonstrate understanding from the previous session. Encourage them to describe how the steps are shown in each model.

For each calculation, create the two other models so that each calculation has three representations. Write out calculations that show the steps of the method. Discuss what is the same and what is different between the representations and between the calculations. This could include many different points:

- The Dienes allow you to see all of the values
- The Dienes are arranged so you can imagine them inside the area model
- Can you see 3 groups of 23? Can you see 23 groups of 3?
- 24×3 is 3 more than 23×3
- 23×4 is 23 more than 23×3

Activity

The activity sheet provides experiences with completing written calculations and creating or labelling models to represent the calculation. Then pupils complete the same task as in session A with a different set of digits. Are they more confident finding all six possibilities? Encourage them to look at the values created and think about anything they notice. Prompt them to select their own values and explore how to make the largest and smallest product. You could extend this to another session to explore further.

[Video guidance](#)

Activity: Models of multiplication

1) Complete each calculation and label or draw a diagram.

$$\begin{array}{r} 24 \\ \times 6 \\ \hline 144 \\ \hline 2 \end{array}$$

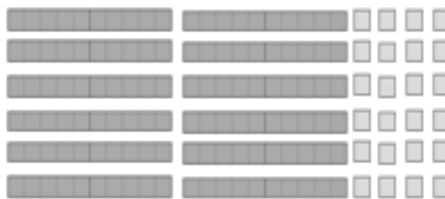

$$\begin{array}{r} 36 \\ \times 9 \\ \hline 324 \\ \hline 5 \end{array}$$

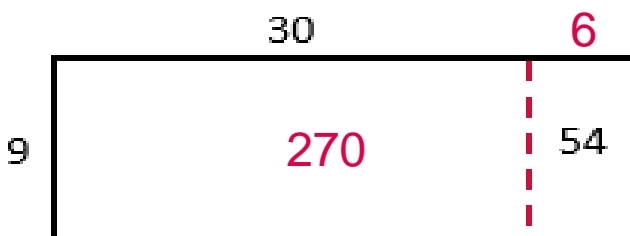

$$\begin{array}{r} 47 \\ \times 4 \\ \hline 188 \\ \hline 2 \end{array}$$

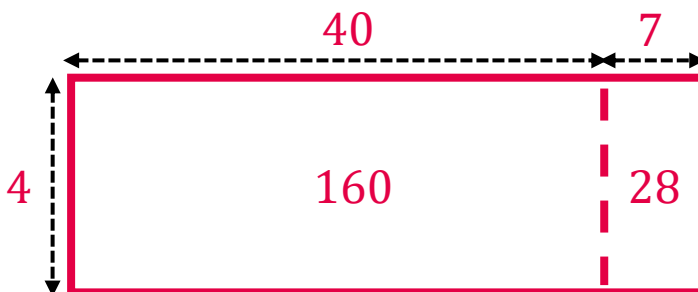

2) Using the digits 4, 5 and 6, what products can you make?

$$\begin{array}{r} 56 \\ \times 4 \\ \hline 224 \\ \hline 2 \end{array}$$

$$\begin{array}{r} 65 \\ \times 4 \\ \hline 260 \\ \hline 2 \end{array}$$

$$\begin{array}{r} 46 \\ \times 5 \\ \hline 230 \\ \hline 3 \end{array}$$

$$\begin{array}{r} 64 \\ \times 5 \\ \hline 320 \\ \hline 2 \end{array}$$

$$\begin{array}{r} 45 \\ \times 6 \\ \hline 270 \\ \hline 3 \end{array}$$

$$\begin{array}{r} 54 \\ \times 6 \\ \hline 324 \\ \hline 2 \end{array}$$

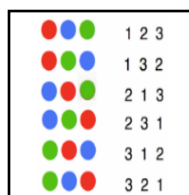

Where is the largest digit for the largest product?

Where is the smallest digit for the smallest product?

Explore how to find the largest and smallest product with other digits.

Pack 10: Multiplication methods	
Session C: 2-digit by 2-digit multiplication	
Resources needed: Dienes	
<p>The purpose of this session is to think about multiplication of a 2-digit number by a 2-digit number. Models are used to support understanding and this underpins understanding of long multiplication which is the focus of the next session.</p>	
<p>Talk Task</p> <p>Four related calculations are represented with an area model and with an image of Dienes in an array that mirrors the area model. Ask pupils to talk about what they can see and what they think they will be asked to do.</p> <p>Ask them what information they can place on the sheet and follow their lead to discuss, label, build and complete the calculations and representations. Use Dienes to build and extend a representation to show each calculation. Ask pupils to sketch images of the Dienes on the sheet (this will support pupils for a task on the activity sheet).</p> <p>At some point, highlight the known facts that are being used and can be seen in the calculations and representations. Draw attention to how much pupils know, building confidence with seeing that longer calculations can be tackled with shorter, known calculations. The key is understanding how and keeping track of the steps - that is what the models can support with.</p> <p>Focus attention on the difference between each calculation and the relationship each has with 14×10. Draw a vertical line on each area model to show 14×10 and discuss what it shows. For example, <i>I can see 14×10 and 14×3.</i></p> <p>This activity and discussion will support the next session on long multiplication. The structure being revealed is the process of the written method and these models will be used to support understanding of the steps.</p> <p>Extend the activity by asking pupils what would come next and sketching calculations such as $14 \times 14 = 196$ and $14 \times 18 = 252$.</p>	
<p>Activity</p> <p>The activity sheet has a similar sequence of calculations and representations. Pupils either complete the calculation or if the calculation is complete they need to work out what is missing from the model. They then complete chains of calculations that can be combined to calculate 2-digit by 2-digit multiplication. They are challenged to select one of the final calculations and draw a model to represent.</p>	<p>Video guidance</p> 



Activity: 2-digit by 2-digit multiplication

1) Complete the drawings and the calculations

$$\square \times 10 = 160$$

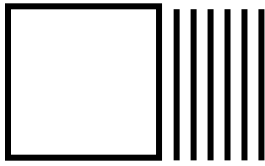

$$16 \times \square = 176$$

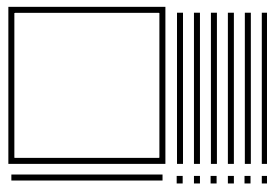

$$16 \times 12 = 192$$

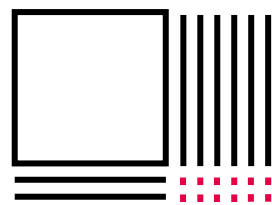

$$16 \times \square = 208$$

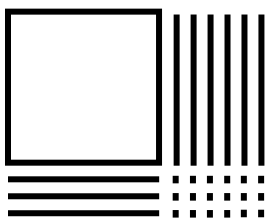

$$16 \times 14 = 224$$

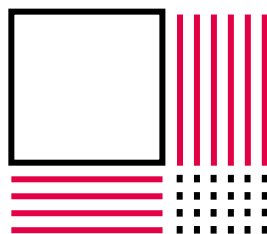

$$16 \times 15 = \square$$

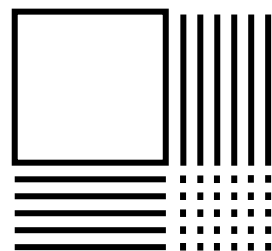



2) Complete the calculations

a) $24 \times 2 = 48$
 $24 \times 3 = 72$
 $24 \times 30 = 720$
 $24 \times 32 = 768$

b) $45 = 15 \times 3$
 $60 = 15 \times 4$
 $600 = 15 \times 40$
 $645 = 15 \times 43$

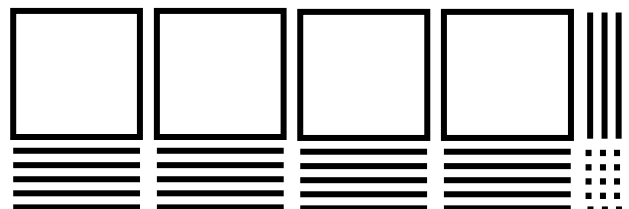
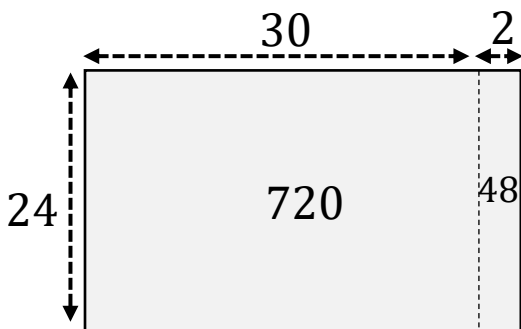
c) Choose one set of calculations and draw a diagram:



Pack 10: Multiplication methods	
Session D: Long multiplication	
Resources needed: Dienes	
The purpose of this session is to use models to focus on understanding and explaining the written method of long multiplication.	
Talk Task The sheet provides prompts to explore the calculation 34×12 . Prepare for this session by completing this calculation using long multiplication and thinking about what runs through your head. You want pupils to know how to do the method and ideally to see how this connects with what they already understand about multiplication. Talk through each step of the method, using Dienes to make sense of what is happening. Take the opportunity to be flexible in interpreting multiplication, using arrays to see calculations in two ways. Build up each part of the calculation and then arrange them into a rectangle to show the final step of adding. This rectangle of Dienes has sides of length 34 and length 12. This is the frame that is provided on the sheet. Draw this around the Dienes or label the array. Take time to build this model again using the frame. Write calculations to show each step and connect this to the long multiplication method. Draw a rectangle around the array of Dienes and remove them to create an open array or area model and connect this with the written method. Then explore varying the calculation by changing a digit and looking at what effect this has on the model and on the product. Encourage pupils to build and sketch models and give clear explanations that make connections with the calculation already explored. 34×13 is 34 more than 34×12 34×22 is 340 more than 34×12 Extend the session by exploring the effect of varying other digits.	
Activity The activity sheet provides practice with the written method of long multiplication. Models are provided for the first two calculations and pupils are to write more information into these. The final calculation has space for pupils to create their own representation.	Video guidance 



Activity: Long multiplication

1) Label the model and complete the calculation

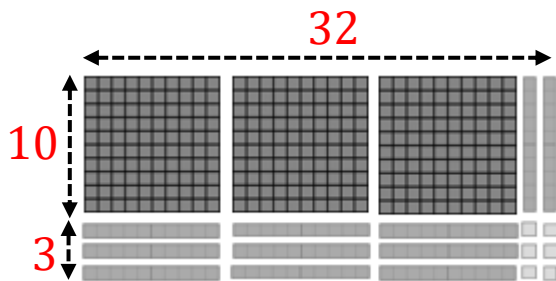

	3	2
×	1	3
	9	6
3	2	0
4	1	6

2) Label the model and complete the calculation

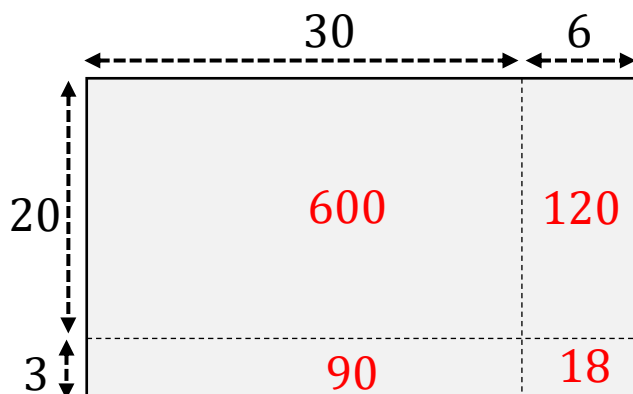

	3	6
×	2	3
1	0	8
7	2	0
8	2	8

3) Draw a model and complete the calculation

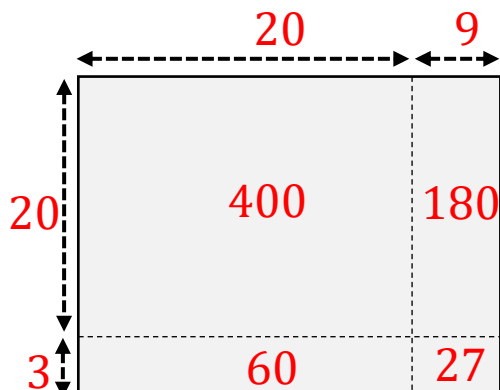

	2	9
×	2	3
	8	7
5	8	0
6	9	7

Pack 12: Division methods	
Session A: Using knowledge of multiples	
Resources needed: Dienes blocks	
<p>The purpose of this session is to build confidence with using knowledge of multiples to divide. Dienes in arrays are used to reveal multiples and support explanations.</p>	
<p>Talk Task Ask pupils to describe the arrays of Dienes and tell you what they can see. You can talk about if you notice any similarities and differences and what calculations they could represent. This task mirrors a task in an earlier pack about multiplication strategies and pupils should be familiar with this model for multiplication.</p> <p>Under each array is a division calculation that is deliberately written to show the same structure as the Dienes blocks. There are a lot of symbols in these calculations so take the time to make sense of these and explain how each model shows them.</p> <p><i>To divide 52 by 4, partition 52 into 40 and 12 and divide each part. $40 \div 4 = 10$ and $12 \div 4 = 3$. So, $52 \div 4 = 13$</i></p> <p>Discuss each calculation and then focus on what changes in the calculations going down the page. What would come next if they continued?</p> <p>$12 \div 4 = 3$ $52 \div 4 = 13$ $92 \div 4 = 23$ $132 \div 4 = 33$</p> <p>Ask pupils to explain why there is a difference of 40 blocks between each model and the result of the division has a difference of 10.</p> <p>At the end of the page, a number line is shown with the values from the model above. <i>1 part is 4, 3 parts is 12, 13 parts is 52, 23 parts is 92, ...</i> Notice that the values on the line are positioned to line up with the length of the Dienes models. Spend time describing how the number line is connected to the Dienes and the calculations.</p>	
<p>Activity The activity sheet provides a similar experience as in the talk task connecting a model of Dienes to area models using rectangles.</p> <p>Pupils have the opportunity to sketch models to represent calculations and complete statements to describe the relationship between calculations.</p>	<p>Video guidance</p> 



Activity: Using knowledge of multiples

1) Label the area models and complete the calculations.

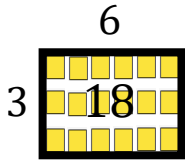

$$18 \div 3 = 6$$

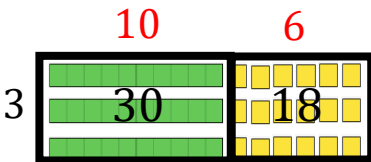

$$48 \div 3 = 10 + 6 = 16$$

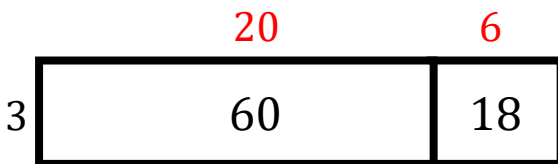

$$78 \div 3 = 20 + 6 = 26$$

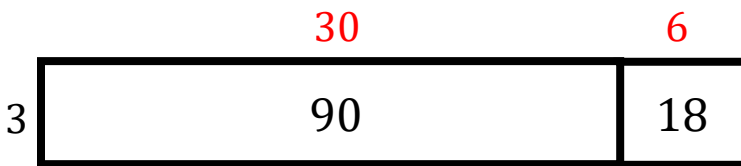

$$108 \div 3 = 30 + 6 = 36$$

3) Draw models to represent these calculations.

$$24 \div 3 = 8$$

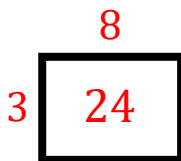

$$54 \div 3 = 18$$

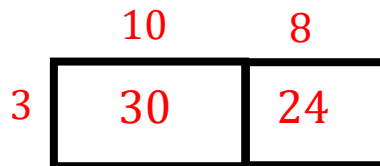

$$84 \div 3 = 28$$

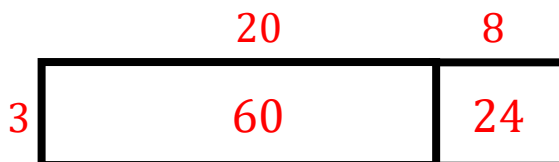

Pack 12: Division methods	
Session B: Written division method	
Resources needed: Dienes blocks	
<p>The purpose of this session is to use and explain the written method of division. Aim for more than describing the steps needed to complete the method. Support pupils in using the manipulatives and models to show and explain what is happening as each step is carried out.</p>	
<p>Talk Task Use Dienes to show $138 \div 6$ in two different ways using the prompts in the speech bubbles.</p> <p><i>To split 138 into 6 equal groups the 100 needs to be regrouped into 10 tens and a ten is regrouped as 10 ones. Seeing 138 as 12 tens and 18 ones allows for division into 6 groups easily.</i></p> <p><i>To split 138 into groups of 6 you could get 138 ones and make groups of 6. Or, use knowledge of multiples. 10 groups of 6 is 60 and 20 groups of 6 is 120. There are 13 ones left and this is 3 groups of 6.</i></p> <p>Talk through the steps of completing the written method of division to get the same result of 23. The pattern of thought is something similar to this:</p> <p><i>6 doesn't go into 1 so regroup. 6 goes into 13 two times with one remaining, regroup. 6 goes into 18 three times.</i></p> <p>When completing this method, each digit is thought about in turn and breaking it down into steps means you lose sight of the whole calculation. Connect the steps of the written method to the Dienes representation.</p> <p>Arranging the blocks into an array with side length 6 and 23 and ask pupils to show you the 6 groups of 23 and the 23 groups of 6.</p> <p>Extend the activity by repeating the experience with another calculation such as $152 \div 4$ or $342 \div 3$.</p>	
<p>Activity The activity sheet has a series of word problems that use different language structures involving division. Pupils may need support deciding what calculation to complete. Space is provided for pupils to write calculations and show any steps of calculation strategies. Encourage pupils to decide if they want to use a written method or if there is a different strategy they prefer.</p>	<p><u>Video guidance</u></p> 



Activity: Written division method

<p>A lottery winning of £216 is shared equally between 8 people.</p> $8 \overline{) 216}$ <p>Each person gets £27</p>	<p>216 eggs are packed in boxes of 6.</p> <p>There are 36 boxes.</p>
<p>Your journey was 108 miles. It was three times longer than my journey.</p> <p>My journey was 36 miles.</p>	<p>A charity event sold four times as many adult tickets than child tickets. They sold 432 adult tickets.</p> <p>They sold 108 child tickets.</p>
<p>A new bike costs £327. It is three times as much money as a new pair of trainers.</p> <p>The trainers cost £109</p>	<p>In the canteen they serve 1 egg with 2 slices of toast. They have used 108 slices of bread.</p> <p>They have used 54 eggs.</p>

Pack 12: Division methods

Session C: Written long division method

Resources needed: Dienes blocks

The purpose of this session is to use and explain the written method of division. Support pupils in using the manipulatives and models to show and explain what is happening as each step is carried out and to make connections with existing understanding of division and multiplication.

Talk Task

The sheet provides prompts to explore the calculation $448 \div 14$

Ask pupils to make 448 with Dienes and then challenge them to arrange the blocks into a rectangle that has one side of length 14. Give them time to play around with how to do this and to decide if any blocks need to be regrouped.

Once the array is completed place labels onto the array to identify that the other side has length 32 and to show the value of different sections. Ask pupils to show you the 14 groups of 32 and then to show the 32 groups of 14.

Turn attention to the written method of long multiplication that has been completed for this calculation. Ask pupils if they have seen anything like this before and if they know anything about how it works.

Talk through the steps of this method, writing them out again and then spend time making connections with the array of Dienes. Does the regrouping in the method match the blocks they regrouped when building the model?

At some point check that the answer is reasonable. E.g. I know 15×30 is 450 and this calculation will be close to this answer.

Write out multiples of 14 and talk about which ones were used in this calculation. Can they identify the 42 tens and the 28 ones in the model and talk about what they represent?

Extend this session by repeating with other examples. If pupils have never seen this method before, you may wish to repeat this session or provide similar experiences to build confidence and fluency with using long division.

Activity

The activity sheet has a model for pupils to label to represent a calculation which they use written long division to complete. Then a partially completed calculation is provided along with multiples that pupils can select to complete the steps.

[Video guidance](#)



Activity: Written long division method

- 1) Label the array that can be used to represent and complete the written division method.

$$416 \div 13$$

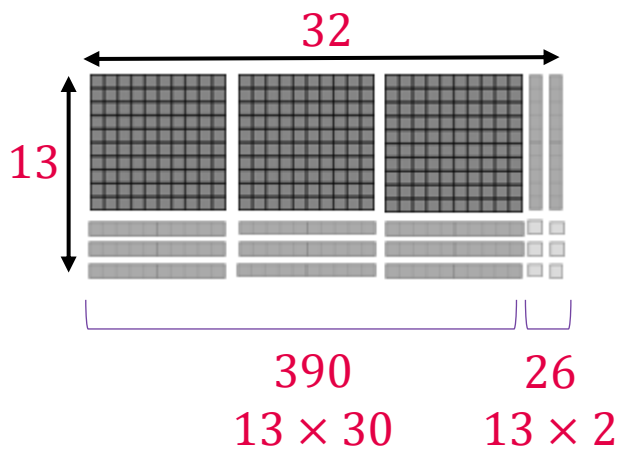

$$\begin{array}{r}
 32 \\
 13 \overline{) 416} \\
 \underline{-39} \\
 26 \\
 \underline{-26} \\
 0
 \end{array}$$

- 2) The long division algorithm has been used to calculate:

$$3542 \div 14$$

Which multiple of 14 goes in each space?

Multiples of 14:

14	28	42
56	70	84
98	112	126

$$\begin{array}{r}
 253 \\
 14 \overline{) 3542} \\
 \underline{-28} \\
 74 \\
 \underline{-70} \\
 42 \\
 \underline{-42} \\
 0
 \end{array}$$

Pack 12: Division methods	
Session D: Division strategies	
Resources needed: Individual whiteboards to sketch bar models	
<p>The purpose of this session is to explore different division strategies that can be used instead of the written method of long division. Knowledge of factors and multiples are used to calculate and bar models are used to represent.</p>	
<p>Talk Task</p> <p>Three calculation strategies for completing are shown and represented with bars. Ask pupils to look at the models and tell you what they see and if there is any other information they can add to each model.</p> <p>What is the same? What is different? What calculations can these represent?</p> <p>Talk through each strategy, reading the speech bubble and thinking about more information to clearly explain what is going on.</p> <p>Encourage pupils to use the models to explain and show why each strategy works. They can think of other, simpler examples that use the same techniques to support their understanding.</p> <p><i>To divide by 18 you can halve and then divide by 9. Another example of this is:</i> $180 \div 18 = 90 \div 9$</p> <p><i>I can use knowledge of the factors of 18. I know $18 = 3 \times 6$. This means I can divide by 3 and then by 6 and it is the same as dividing by 18. Another example of this is $180 \div 3 = 60$ and $60 \div 6$ is equal to 10. $180 \div 18 = 10$</i></p> <p><i>To divide 216 by 18, look at the number 216 and think about multiples of 18.</i> $216 = 180 + 36$</p> <p>Having discussed all three strategies, talk about which one you would choose to do and why.</p> <p>Repeat each strategy with another calculation involving dividing by 18. For example asking pupils to calculate and sketch models to show $414 \div 18$</p>	
<p>Activity</p> <p>The activity sheet provides an explanation of a strategy that pupils have not yet explored for division. It is based on knowledge of multiples and involves subtraction to adjust from a larger multiple. Encourage them to make sense of this using what they know. If needed, you could turn the activity sheet into another session to discuss the strategy further.</p>	<p><u>Video guidance</u></p> 



Activity: Division strategies

$$7 \times 40 = 280$$

$$266 \text{ is } 14 \text{ less}$$

$$\dots$$

$$266 \div 7 = 38$$



Explain the missing step to show this is correct.
Label the models to represent the steps of this strategy.

He is using knowledge of multiples of 7 to divide by 7.

266 is 14 less than 280
It is 2 groups of 7 less.

If 280 is 40 groups of 7
then 266 must be 38
groups of 7

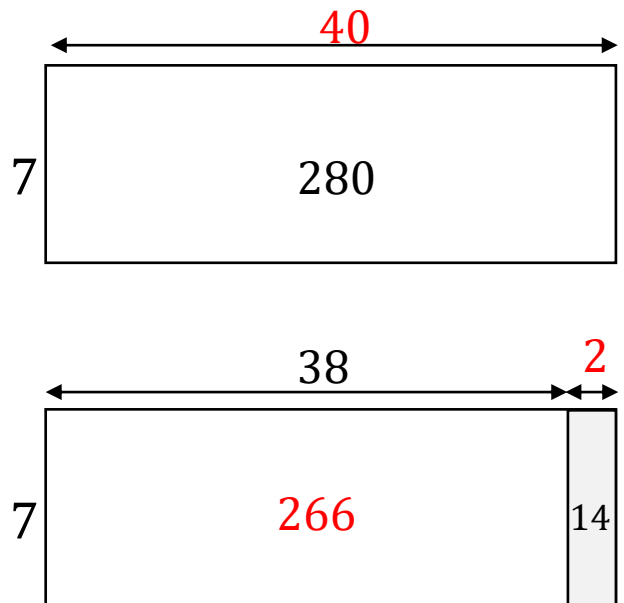

Use a similar strategy to use $4 \times 80 = 320$ to work out $312 \div 4$
Draw a model to represent.

312 is 8 less than 320
312 is 2 groups of 4 less than 320
If 320 is 4×80 then 312 is 4×78
So, $312 \div 4 = 78$

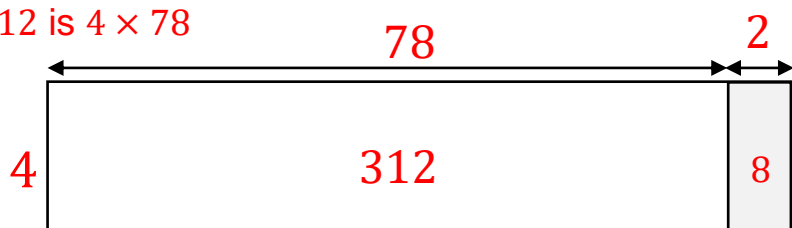

Loved a session?
Got some ideas for improvements?
Spotted a typo?

Let us know your feedback [here](#)

